

SECTION Y-Y

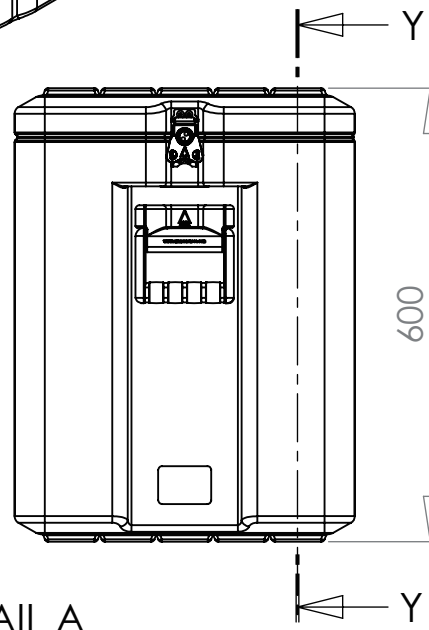

DETAIL A  
SCALE 1 : 5

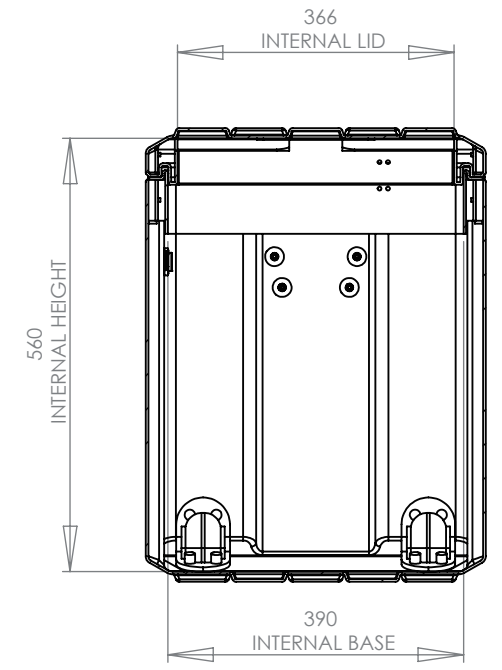
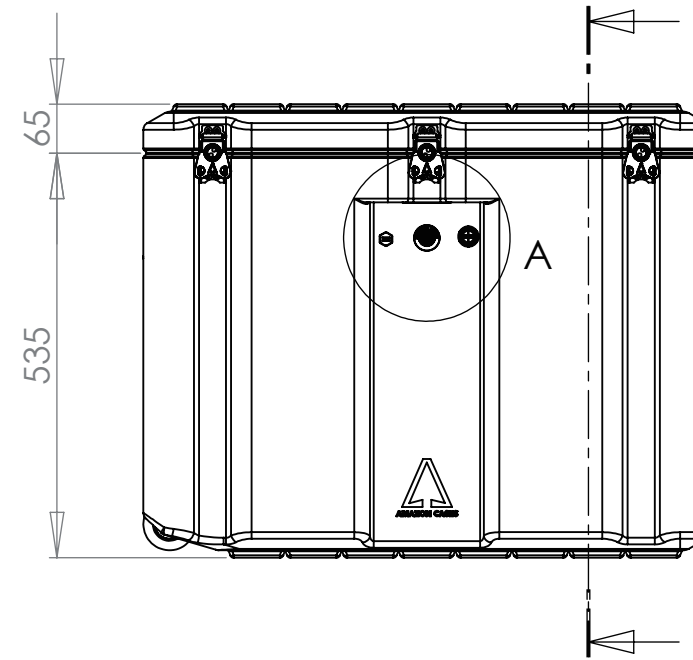

SECTION Z-Z

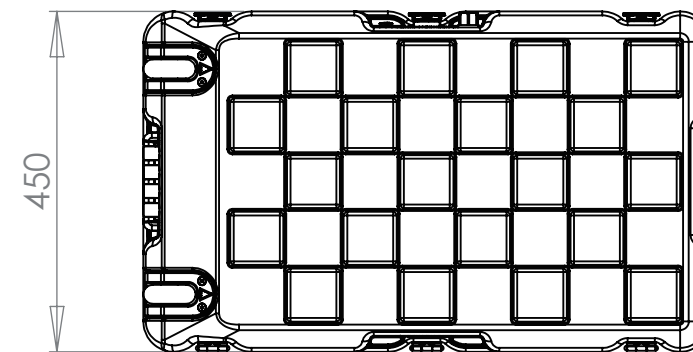
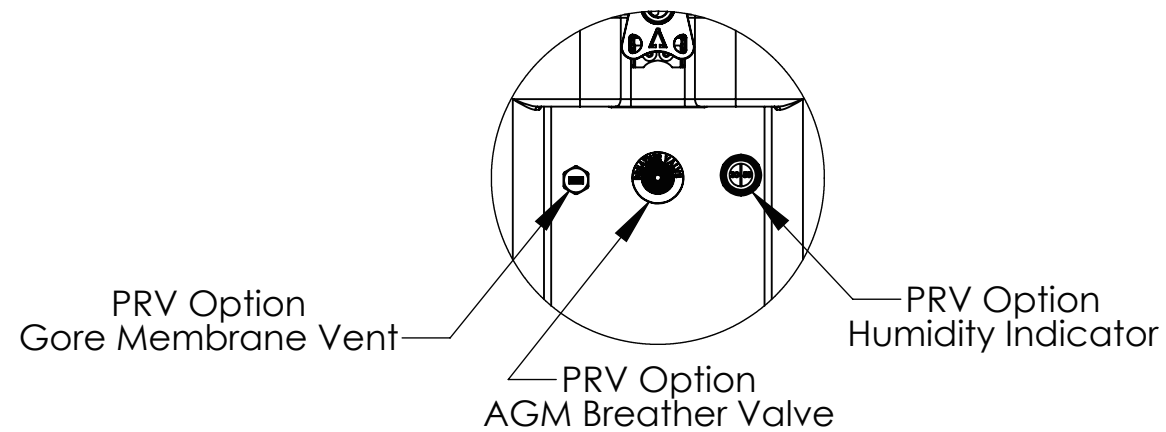

Options Available	Option Selected	Qty	Part #	Nato Stock No (NSN)		
Wheel Kit	Y	01	AAW001	8145-99-729-6181		
AGM Breather Valve	Y	01	AAPRV	Moulding Tolerance +/- (1%+1mm)		
Gore Membrane Vent	Y	01	AAGTV	External Dimensions (mm)		
Humidity Indicator	Y	01	AAHI	Length	Width	Height
Tie Down Anchor	N	00	AATD001	750	450	600
Padlockable Latch	N	00	AALPLBK	Internal Dimensions (mm)		
Latch	Y	05	AALBK	Length	Width	Height
Plastic Handles	Y	02	AAHPL	690	390	560

Title			Drg. No.	
Amazon Case AC7545-5307			AC7545-5307	
Drawn By	Date	Sheet No.	Issue No.	
MW	18/06/2010	1 Of 1	1	
Dimensions In Millimeters		Third Angle Projection		
Do Not Scale				

**CP Cases Ltd.**

Copyright CP Cases Limited.  
This drawing is the property of CP Cases Limited & the information on it is confidential & it is not to be used for any other purpose without the prior written consent of CP Cases Limited.