

SECTION Y-Y

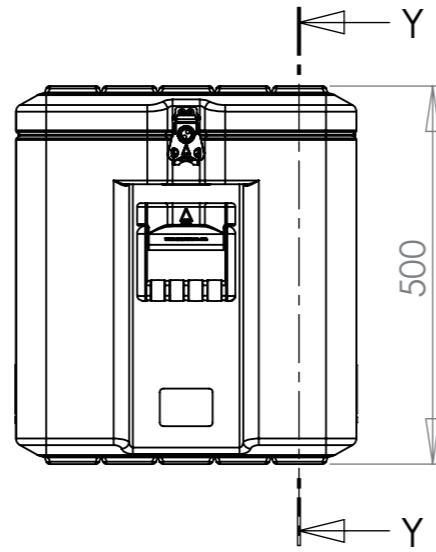

DETAIL A
SCALE 1 : 5

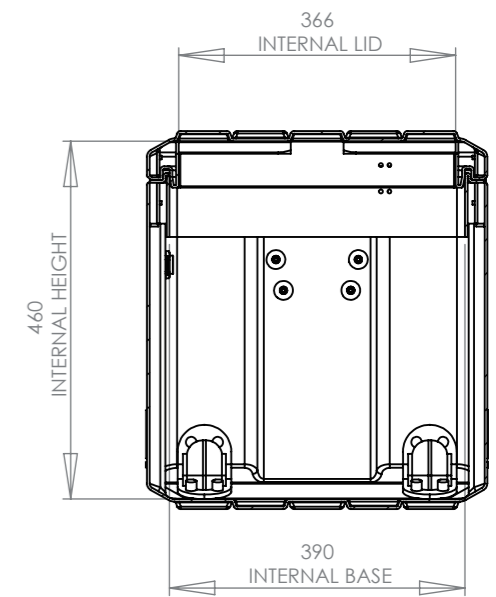
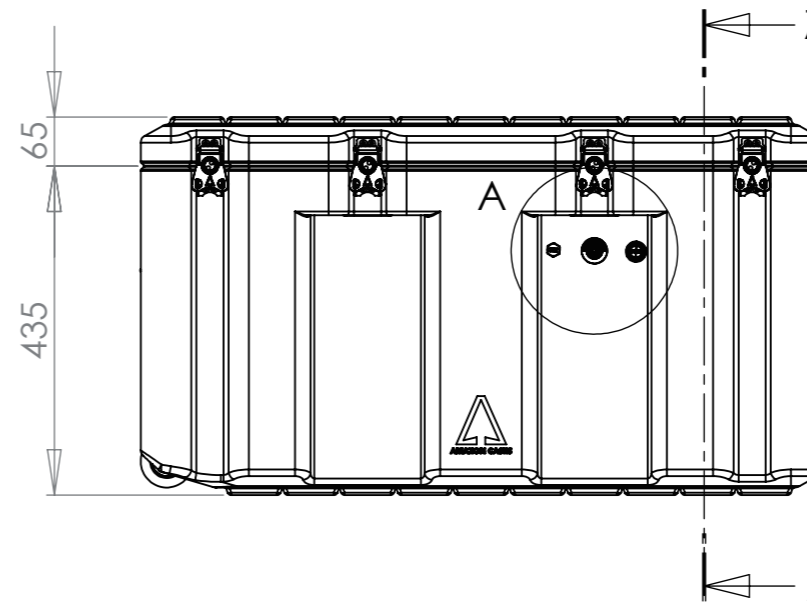

SECTION Z-Z

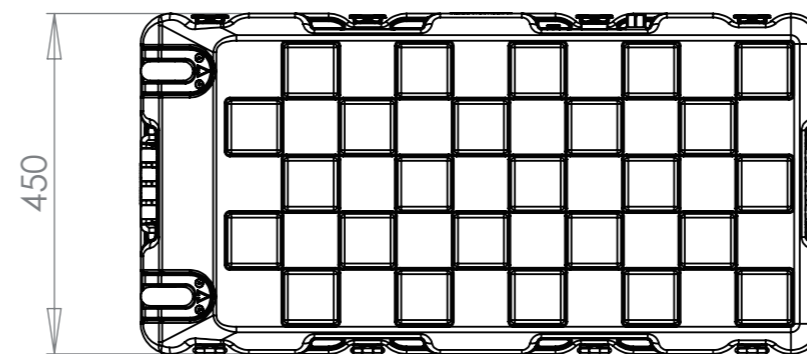
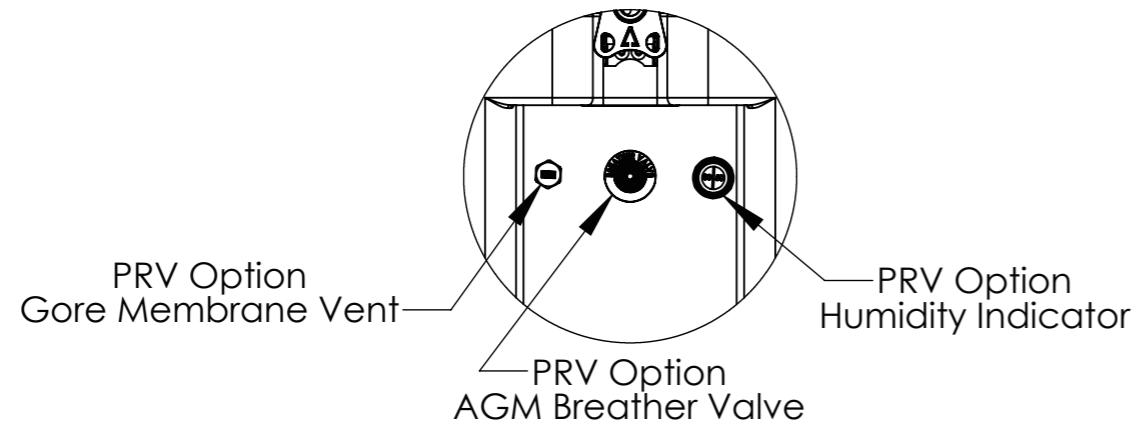

Options Available	Option Selected	Qty	Part #	Nato Stock No (NSN)		
Wheel Kit	Y	01	AAW001	8145-99-362-3513		
AGM Breather Valve	Y	01	AAPRV	Moulding Tolerance +/- (1%+1mm)		
Gore Membrane Vent	Y	01	AAGTV	External Dimensions (mm)		
Humidity Indicator	Y	01	AAHI	Length	Width	Height
Tie Down Anchor	N	00	AATD001	900	450	500
Padlockable Latch	N	00	AALPLBK	Internal Dimensions (mm)		
Latch	Y	06	AALBK	Length	Width	Height
Plastic Handles	Y	02	AAHPL	840	390	460

Title			Drg. No.	
Amazon Case AC9045-4307			AC9045-4307	
Drawn By	Date	Sheet No.	Issue No.	
MW	22/04/2010	1 Of 1	1	
Dimensions In Millimeters		Third Angle Projection		
Do Not Scale				

CP Cases Ltd.

Copyright CP Cases Limited.
This drawing is the property of CP Cases Limited & the information on it is confidential & it is not to be used for any other purpose without the prior written consent of CP Cases Limited.